

SPECIFICATIONS

DESCRIPTION:

Compact adjustable LED accent fixture. Suitable for wet/damp/dry location installations.

MATERIAL:

Standard overall material is 6061 aluminum.

FINISH:

- AA - Anodized Satin Aluminum
- AP - Powder Coat Aluminum
- BK - Powder Coat Black
- BZ - Powder Coat Bronze
- WT - Powder Coat White
- N - Natural, for Stainless Steel and Brass

LED OPTIONS

Integral high output LED, warm white 85 CRI (90 available)
2700K or 3000K Standard (4000K, 5000K, & 6000K available)
1LED - 1W (42 lumens)

Optics

- SP - Spot, 12°
- NF - Narrow Flood, 24°
- FL - Flood, 36°

VOLTAGE:

Remote 350mA (1W) constant current driver required, not included. See options below.

MOUNTING:

Fixture is designed with a 1/2-NPS adjustable mounting stem.

OPTIONS:

Glare shields

- GL-1 - Angled, aluminum
- GL-2 - Angled, brass
- GL-3 - Straight, aluminum
- GL-4 - Straight, brass

Lenses/Louvers/Color Filters

- LA-1-8 - Hexcell Louver (Black)
- LA-2-8 - Prismatic lens
- LA-3-8 - Linear spread lens
- LA-4-8 - Soft focus lens (diffused)
- LA-5-8 - Moonlight lens
- LA-6-8 - Blue lens

LED Constant Current Drivers

- HLD-3-350-12 - 4W 350mA 12 VAC driver
- HLD-3-350-U - 3W 350mA 120-277 VAC driver

See fixture accessories for more information.

SAMPLE ORDER SPECIFICATION:

HL-300-LED-2b-N-GL-2

RATING:

Wet/damp/dry location.



MADE IN THE USA

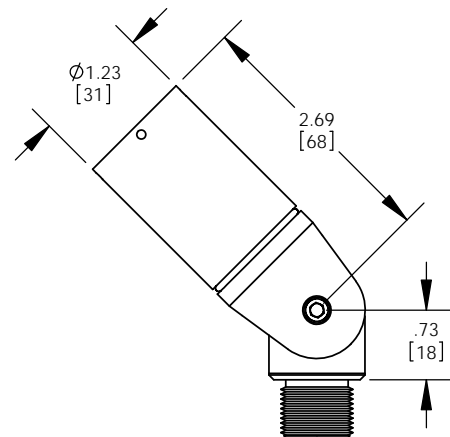

ORDER SPECIFICATION: _____ - _____ - _____ - _____ - _____
Fixture Finish Optics Voltage Options/Access.

PROJECT: _____
 APPROVED: _____
 NOTE: _____
 TYPE: _____

H HEVI LITE, INC.
 9714 Variel Ave, Chatsworth, CA 91311
 Tel., (818) 341-8091 - Fax (818) 998-1986
 Web Site <http://www.hevilite.com>

CATALOG NUMBER:
HL-300-LED

Driver Options



HLD-3-350-12

Compact dimmable 12-Volt / 350mA constant current LED driver for 1-3W LEDs.
Driver is dimmable standard with MLV TRIAC dimmer.



HLD-3-350-U

Compact universal voltage (100-277v) 350mA constant current LED driver for 1-3W LEDs. Non-dimmable.

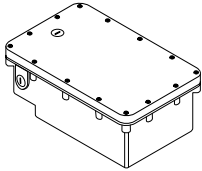

HLD-CBB

Direct burial composite enclosure with (1)LED driver and (1)fixture mount location.
Enclosure comes standard with junction compartment and anti-siphon chamber ensures no water can enter the main housing.

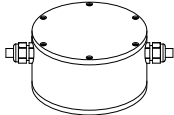

H-POD-LED

Direct burial LED Driver pod with (1) driver. Pod is equipped with moisture-lock cords to prevent water wicking.
Suitable for wet/damp/dry location installation.

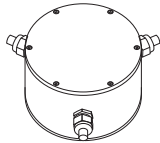

H-POD-LED-2X

Direct burial LED Driver pod with (2) LED drivers. Pod is equipped with moisture-lock cords to prevent water wicking.
Suitable for wet/damp/dry location installation.

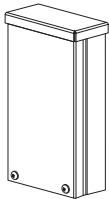

HL-RD

3R rated rain tight stainless steel enclosure with (1) LED driver. Suitable for wet/damp/dry location installations.

HL-RD-2X

3R rated rain tight stainless steel enclosure with (2) LED drivers. Suitable for wet/damp/dry location installations.

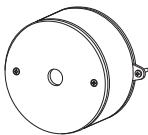

SMED

Surface mount canopy with (1) LED driver, for (1) fixture. Suitable for wet/damp/dry location installations.

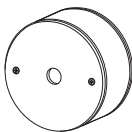

WMED

Wall mount canopy with (1) LED driver, for (1) fixture. Suitable for wet/damp/dry location installations.

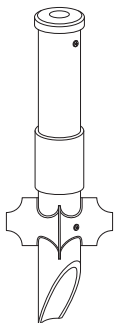

GM-9-LED

LED driver in PVC landscape post/mounting spike for ground mounting applications.
Suitable for wet/damp/dry location installations.